

PLAN

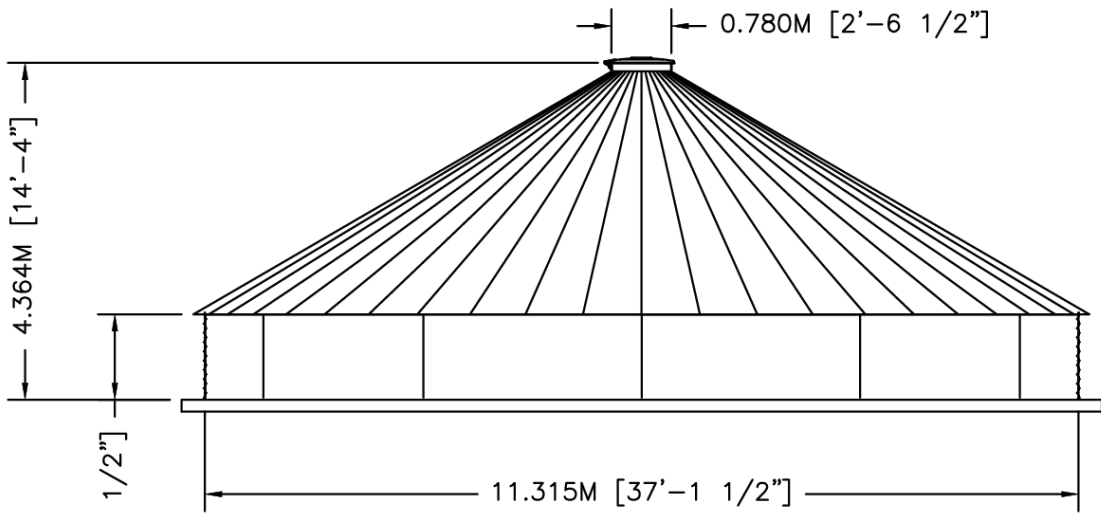

ELEVATION



	BY	DATE	TITLE	
DWN	XXX	XX/XX/XX	WTU12-01 30"PR 30DEG V-RIB	
CKD			NOMINAL CAPACITY - 98.333 M3 [25,977 GAL]	
ENG			DWG. NO. SCT3701-VR WTU12-01	REV. NO.
	SIZE:	SCALE:	SHEET	OF
	A	1/8"=1'-0"	1	1